

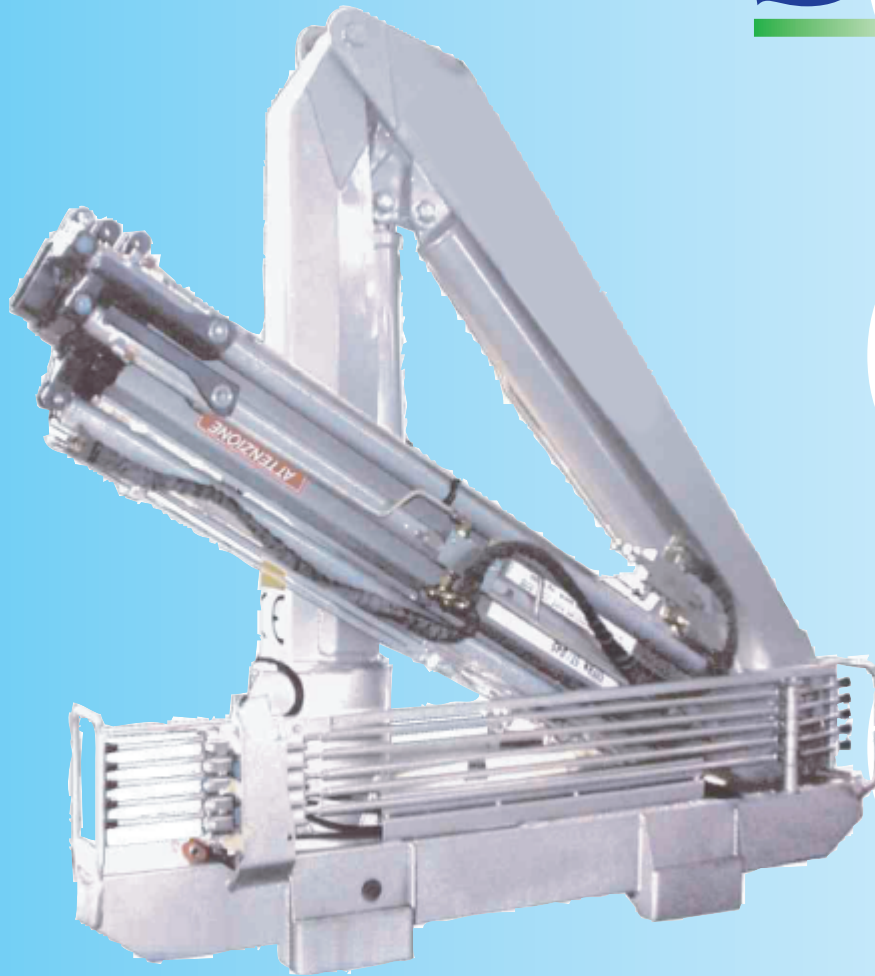

NEW  
**STERN**  
INTERNATIONAL



 **CARATTERISTICHE TECNICHE**

MOMENTO MAX SOLLEVAMENTO 55.68 kNm

ROTAZIONE 210°  
MOMENTO DI ROTAZIONE 6.45 kNm  
PRESSIONE DI ESERCIZIO 290 bar

PORTATA AL DISTRIBUTORE 13 l/min

 **TECHNICAL DATA**

MAX LIFTING MOMENT 55.68 kNm

SLEWING 210°  
SLEWING MOMENT 6.45 kNm  
WORKING PRESSURE 290 bar

DELIVERY TO THE DISTRIBUTOR 13 l/min

 **CARACTERISTIQUES TECHNIQUES**

MOMENT MAX DE LEVAGE 55.68 kNm

ROTATION 210°  
MOMENT DE ROTATION 6.45 kNm  
PRESSION DE TRAVAIL 290 bar

DEBIT AU DISTRIBUTEUR 13 l/min

 **DATOS TECNICOS**

MOMENTO DE ELEVACION 55.68 kNm

GIRO 210°  
MOMENTO DE GIRO 6.45 kNm  
PRESION DE TRABAJO 290 bar

CAUDAL AL DISTRIBUIDOR 13 l/min

 **TECHNISCE ANGABEN**

MAX HUBMOMENT 55.68 kNm

SCHWENKBEREICH 210°  
DREHMOMENT 6.45 kNm  
DRUCK 290 bar

DURCHFLUSS ZUM STELIERBLOCK 13 l/min

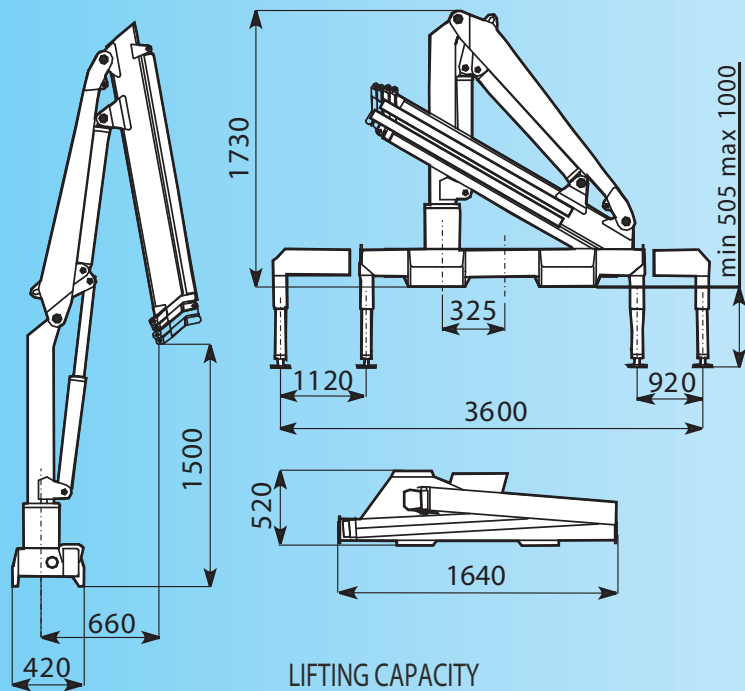



**LIFTING CAPACITY**

m 3.50 (ft 11.48)	kg 1450 (lb 3190)
m 4.90 (ft 16.08)	kg 1000 (lb 2200)
m 6.30 (ft 20.37)	kg 760 (lb 1672)
m 7.70 (ft 25.96)	kg 590 (lb 1298)

# S 6000

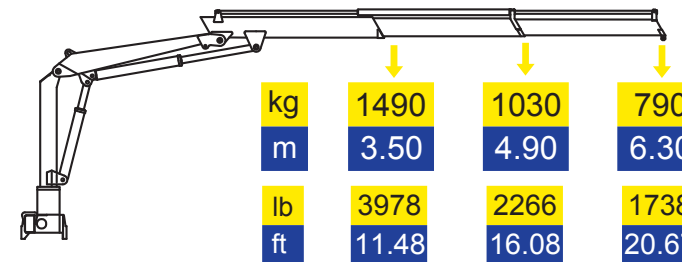
## S 6000.2



 **500 (1100 lb)**

PESO CON STABILIZZATORI  
WEIGHT WITH STABILIZERS  
PESO CON ESTABILIZADORES  
POIDS AVEC STABILIZATEURS  
GEWICHT MIT FÜSSE

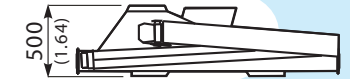

## S 6000.3

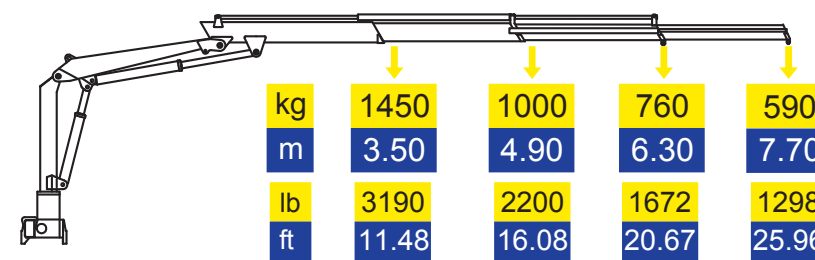



 **540 (1188 lb)**

PESO CON STABILIZZATORI  
WEIGHT WITH STABILIZERS  
PESO CON ESTABILIZADORES  
POIDS AVEC STABILIZATEURS  
GEWICHT MIT FÜSSE

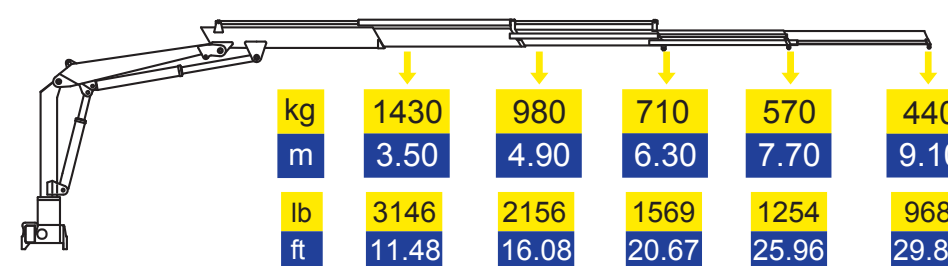

## S 6000.4



 **580 (1276 lb)**

PESO CON STABILIZZATORI  
WEIGHT WITH STABILIZERS  
PESO CON ESTABILIZADORES  
POIDS AVEC STABILIZATEURS  
GEWICHT MIT FÜSSE



NEW  
**STERN**  
INTERNATIONAL



Via Bovi Campeggi, 6  
40131 Bologna  
Tel +39 051/523517  
email: sterninternational@libero.it